

Editorial Team

EDITOR IN CHIEF

Sri Wahyuningsih

<https://scholar.google.co.id/citations?user=KvHbZpkAAAAJ&hl=id> (<https://scholar.google.co.id/citations?user=KvHbZpkAAAAJ&hl=id>)
R&D Center for Post and Informatics, MCIT, Indonesia

ASSOCIATE EDITOR

Ir. Ashwin Sasongko, M.Sc., Ph.D.

<https://www.scopus.com/authid/detail.uri?authorId=57164855100> (<https://www.scopus.com/authid/detail.uri?authorId=57164855100>)
<https://scholar.google.com/citations?user=liUa11YAAAAJ&hl=en> (<https://scholar.google.com/citations?user=liUa11YAAAAJ&hl=en>)

BRIN

Riza Azmi

<https://www.scopus.com/authid/detail.uri?authorId=57210234585> (<https://www.scopus.com/authid/detail.uri?authorId=57210234585>)
Ministry of ICT Republic of Indonesia, Indonesia

Aldhino Anggoroesar

<http://www.scopus.com/authid/detail.uri?authorId=48860890800> (<http://www.scopus.com/authid/detail.uri?authorId=48860890800>)
R&D Center of Post and Informatics, MCIT, Indonesia

Scopus ID: 48860890800 h-index:3

Kasmad Ariansyah

<https://www.scopus.com/authid/detail.uri?authorId=57202162180> (<https://www.scopus.com/authid/detail.uri?authorId=57202162180>)
R&D Center of Post and Informatics, MCIT, Indonesia, Indonesia

Diah Yuniarti

<https://www.scopus.com/authid/detail.uri?authorId=57203095658> (<https://www.scopus.com/authid/detail.uri?authorId=57203095658>)
R&D Center for Post and Informatics, MCIT, Indonesia

Sri Ariyanti

<https://www.scopus.com/authid/detail.uri?authorId=57201720378> (<https://www.scopus.com/authid/detail.uri?authorId=57201720378>)
R&D Center for Post and Informatics, MCIT, Indonesia

Vidyantina Heppy Anandhita

<https://www.scopus.com/authid/detail.uri?authorId=57208862611> (<https://www.scopus.com/authid/detail.uri?authorId=57208862611>)
R&D Center for Post and Informatics, MCIT, Indonesia

Awangga Febian Surya Admaja

<https://www.scopus.com/authid/detail.uri?authorId=57202158075> (<https://www.scopus.com/authid/detail.uri?authorId=57202158075>)
R&D Center of Post and ICT Resources, Ministry of ICT Republic of Indonesia, Indonesia

Amry Daulat Gultom

<https://scholar.google.co.id/citations?user=uAmEdA8AAAAJ&hl=en&oi=ao> (<https://scholar.google.co.id/citations?user=uAmEdA8AAAAJ&hl=en&oi=ao>)
R&D Center for Post and Informatics, MCIT, Indonesia

TECHNICAL TEAM

Riva'atul Adaniah Wahab

<https://www.scopus.com/results/authorNamesList.uri?sort=count-f&src=al&sid=3f26956e18997465e372c469845c69e8&sot=al&sdt=al&sl=52&s=AUTHLASTNAME%28wahab%29+AND+AUTHFIRST%28riva%27atul+adaniah%29&st1=wahab>
(<https://www.scopus.com/results/authorNamesList.uri?sort=count-f&src=al&sid=3f26956e18997465e372c469845c69e8&sot=al&sdt=al&sl=52&s=AUTHLASTNAME%28wahab%29+AND+AUTHFIRST%28riva%27atul+adaniah%29&st1=wahab>)
R&D Center for Post and Informatics, MCIT, Indonesia

Wardah nia

<https://www.scopus.com/authid/detail.uri?authorId=57208862743> (<https://www.scopus.com/authid/detail.uri?authorId=57208862743>)

R&D Center for Post and Informatics, MCIT, Indonesia

Doria Marselita, S.T, M.T

R&D Center for Post and Informatics, MCIT, Indonesia

Irfan Dhafirwan

R&D Center of Post and Informatics, MCIT, Indonesia

Shera Mayangsari Suwito

R&D Center for Post and Informatics, MCIT, Indonesia

Penni Patmawati Rusman  Mail (<mailto:%70%65%6e%6e%30%30%30%31%40%6b%6f%6d%69%6e%66%6f.%67%6f.%69%64>)

Ministry of Communication and Informatics, Indonesia

ENGLISH EDITOR

Penerjemah Ahli Madya

Direktorat Informasi Dan Komunikasi Perekonomian dan Maritim, Kementerian Komunikasi dan Informatika

SUBMISSION

[Online Submissions \(https://online.bpostel.com/index.php/bpostel/about/submissions#onlineSubmissions\)](https://online.bpostel.com/index.php/bpostel/about/submissions#onlineSubmissions)

[Author Guidelines \(https://online.bpostel.com/index.php/bpostel/about/submissions#authorGuidelines\)](https://online.bpostel.com/index.php/bpostel/about/submissions#authorGuidelines)

PEOPLE

[Editorial Team \(https://online.bpostel.com/index.php/bpostel/about/editorialTeam\)](https://online.bpostel.com/index.php/bpostel/about/editorialTeam)

[Reviewers \(https://online.bpostel.com/index.php/bpostel/Reviewers\)](https://online.bpostel.com/index.php/bpostel/Reviewers)

PUBLICATION POLICIES

[Focus and Scope \(https://online.bpostel.com/index.php/bpostel/about#focusAndScope\)](https://online.bpostel.com/index.php/bpostel/about#focusAndScope)

[Section Policies \(https://online.bpostel.com/index.php/bpostel/about#sectionPolicies\)](https://online.bpostel.com/index.php/bpostel/about#sectionPolicies)

[Peer Review Process \(https://online.bpostel.com/index.php/bpostel/about#peerReviewProcess\)](https://online.bpostel.com/index.php/bpostel/about#peerReviewProcess)

[Publication Frequency \(https://online.bpostel.com/index.php/bpostel/about#publicationFrequency\)](https://online.bpostel.com/index.php/bpostel/about#publicationFrequency)

[Open Access Policy \(https://online.bpostel.com/index.php/bpostel/about#openAccessPolicy\)](https://online.bpostel.com/index.php/bpostel/about#openAccessPolicy)

[Archiving \(https://online.bpostel.com/index.php/bpostel/about#archiving\)](https://online.bpostel.com/index.php/bpostel/about#archiving)

[Publication Ethics \(https://online.bpostel.com/index.php/bpostel/ethics\)](https://online.bpostel.com/index.php/bpostel/ethics)

[Abstracting and Indexing \(https://online.bpostel.com/index.php/bpostel/indexing\)](https://online.bpostel.com/index.php/bpostel/indexing)

[Plagiarism Screening Policy \(https://online.bpostel.com/index.php/bpostel/about#Plagiarism\)](https://online.bpostel.com/index.php/bpostel/about#Plagiarism)

VISITORS

ID	49639
US	3410
MY	711
IN	452
CN	391
SG	275
GB	233
DE	220
Newest:	CM
You:	ID
Today:	30
Month:	107
Total:	57733
Supercounters.com	

Home (<https://bpostel.kominfo.go.id/index.php/bpostel/index>)
/ Archives (<https://bpostel.kominfo.go.id/index.php/bpostel/issue/archive>)
/ Vol. 18 No. 2 (2020): December 2020

Published: 2020-12-27

Front Cover (<https://bpostel.kominfo.go.id/index.php/bpostel/article/view/F1802>)



PDF (<https://bpostel.kominfo.go.id/index.php/bpostel/article/view/F1802/455>)

|  Abstract views: 104 |  PDF Download: 72 |

 <https://doi.org/10.17933/bpostel.2020.F1802> (<https://doi.org/10.17933/bpostel.2020.F1802>)

Preface (<https://bpostel.kominfo.go.id/index.php/bpostel/article/view/P1802>)

PDF (<https://bpostel.kominfo.go.id/index.php/bpostel/article/view/P1802/452>)



|  Abstract views: 64 |  PDF Download: 55 |

 <https://doi.org/10.17933/bpostel.2020.P1802> (<https://doi.org/10.17933/bpostel.2020.P1802>)

LPWA-based IoT Technology Selection for Smart Metering Deployment in Urban and Sub Urban Areas: A State Electricity Company Perspective
(<https://bpostel.kominfo.go.id/index.php/bpostel/article/view/180201>)

Amriane Hidayati, Muhammad Imam Nashiruddin
75-94

PDF (<https://bpostel.kominfo.go.id/index.php/bpostel/article/view/180201/443>)



|  Abstract views: 92 |  PDF Download: 69 |

 <https://doi.org/10.17933/bpostel.2020.180201> (<https://doi.org/10.17933/bpostel.2020.180201>)

The Effect of Internet Usage on Social Capital in Indonesia
(<https://bpostel.kominfo.go.id/index.php/bpostel/article/view/180202>)

Neno Prayitno, Khoirunurrofik Khoirunurrofik
95-110

PDF (<https://bpostel.kominfo.go.id/index.php/bpostel/article/view/180202/442>)

|  Abstract views: 91 |  PDF Download: 88 | Untitled Download: 0 | Untitled Download: 0 | Untitled Download: 0 |

 <https://doi.org/10.17933/bpostel.2020.180202> (<https://doi.org/10.17933/bpostel.2020.180202>)

A Feasibility Analysis of the Use of IEEE 802.11ah to extend 4G Network Coverage
(<https://bpostel.kominfo.go.id/index.php/bpostel/article/view/180203>)

Rini Cahyani, Doan Perdana, Ahmad Tri Hanuranto
111-126

PDF (<https://bpostel.kominfo.go.id/index.php/bpostel/article/view/180203/439>)

|  Abstract views: 90 |  PDF Download: 53 |

 <https://doi.org/10.17933/bpostel.2020.180203> (<https://doi.org/10.17933/bpostel.2020.180203>)

Performance Analysis Of DSDV, AOMDV and ZRP Routing Protocols Application Simulation In Pekanbaru Vehicular Ad Hoc Network (VANET) (<https://bpostel.kominfo.go.id/index.php/bpostel/article/view/180204>)

Ery Safrianti, Linna Oktaviana Sari, Fitriani Saputri
127-144

PDF (<https://bpostel.kominfo.go.id/index.php/bpostel/article/view/180204/448>)



|  Abstract views: 53 |  PDF Download: 36 |

 <https://doi.org/10.17933/bpostel.2020.180204> (<https://doi.org/10.17933/bpostel.2020.180204>)

Coded Random Access Technique Based on Repetition Codes for Prioritizing Emergency Communication (<https://bpostel.kominfo.go.id/index.php/bpostel/article/view/180205>)

Khoirun Ni'amah, Solichah Larasati, Alfin Hikmaturokhman, Muntaqo Alfin Amanaf, Achmad Rizal Danisya
145-158

PDF (<https://bpostel.kominfo.go.id/index.php/bpostel/article/view/180205/450>)



|  Abstract views: 82 |  PDF Download: 43 |

 <https://doi.org/10.17933/bpostel.2020.180205> (<https://doi.org/10.17933/bpostel.2020.180205>)

Comparing Mutual Coupling of Ring Metamaterial on Square and Vivaldi Array Antennas (<https://bpostel.kominfo.go.id/index.php/bpostel/article/view/180206>)

Petrus Kerowe Goran, Eko Setijadi
159-170

PDF (<https://bpostel.kominfo.go.id/index.php/bpostel/article/view/180206/454>)

|  Abstract views: 69 |  PDF Download: 42 |

 <https://doi.org/10.17933/bpostel.2020.180206> (<https://doi.org/10.17933/bpostel.2020.180206>)

Expedition Service Product Development Strategy with Quality Function Deployment Method (<https://bpostel.kominfo.go.id/index.php/bpostel/article/view/180207>)

Indah Nurlina, Septin Puji Astuti, Azis Slamet Wiyono
171-182

PDF (<https://bpostel.kominfo.go.id/index.php/bpostel/article/view/180207/451>)

|  Abstract views: 70 |  PDF Download: 50 |

 <https://doi.org/10.17933/bpostel.2020.180207> (<https://doi.org/10.17933/bpostel.2020.180207>)

Appendix (<https://bpostel.kominfo.go.id/index.php/bpostel/article/view/A1802>)

PDF (<https://bpostel.kominfo.go.id/index.php/bpostel/article/view/A1802/457>)

|  Abstract views: 45 |  PDF Download: 36 |

 <https://doi.org/10.17933/bpostel.2020.A1802> (<https://doi.org/10.17933/bpostel.2020.A1802>)

Back Cover (<https://bpostel.kominfo.go.id/index.php/bpostel/article/view/B1802>)

PDF (<https://bpostel.kominfo.go.id/index.php/bpostel/article/view/B1802/456>)

|  Abstract views: 43 |  PDF Download: 34 |

 <https://doi.org/10.17933/bpostel.2020.B1802> (<https://doi.org/10.17933/bpostel.2020.B1802>)

SUBMISSION

Online Submissions

(<https://online.bpostel.com/index.php/bpostel/about/submissions#onlineSubmissions>)

Author Guidelines

(<https://online.bpostel.com/index.php/bpostel/about/submissions#authorGuidelines>)

PEOPLE

Editorial Team (<https://online.bpostel.com/index.php/bpostel/about/editorialTeam>)

Reviewers (<https://online.bpostel.com/index.php/bpostel/Reviewers>)

PUBLICATION POLICIES

Focus and Scope (<https://online.bpostel.com/index.php/bpostel/about#focusAndScope>)

Section Policies (<https://online.bpostel.com/index.php/bpostel/about#sectionPolicies>)

Peer Review Process (<https://online.bpostel.com/index.php/bpostel/about#peerReviewProcess>)

Publication Frequency

(<https://online.bpostel.com/index.php/bpostel/about#publicationFrequency>)

Open Access Policy (<https://online.bpostel.com/index.php/bpostel/about#openAccessPolicy>)

Archiving (<https://online.bpostel.com/index.php/bpostel/about#archiving>)

Publication Ethics (<https://online.bpostel.com/index.php/bpostel/ethics>)

Abstracting and Indexing (<https://online.bpostel.com/index.php/bpostel/indexing>)

Plagiarism Screening Policy (<https://online.bpostel.com/index.php/bpostel/about#Plagiarism>)

VISITORS



Coded Random Access Technique Based on Repetition Codes for Prioritizing Emergency Communication

Khoirun Ni'amah¹, Solichah Larasati², Alfin Hikmaturokhman³, Muntaqo Alfin Amanaf⁴, Achmad Rizal Danisya⁵

^{1,2,3,4,5}Institut Teknologi Telkom Purwokerto

^{1,2,3,4,5}Jl. D.I Panjaitan No. 128 Purwokerto

email: {¹irun, ²laras, ³alfin, ⁴muntaqo, ⁵achmad.rizal} @ittelkom-pwt.ac.id

ARTICLE INFORMATION

Received on 29 October 2019

Revised on 26 November 2020

Accepted on 26 November 2020

Keywords:

Repetition Codes

Coded Random Access

Super-dense Networks

EXIT Chart

ABSTRACT

This research uses repetition codes based on Coded Random Access (CRA) to support Internet of Things (IoT) to give priority to emergency communications in super-dense networks. Degree distribution for emergency group and general group are obtained with extrinsic information transfer (EXIT) analysis to achieve small error performance shown by the very small gap between emergency group curve and general group curve. This research also evaluates performance by observing throughput and packet-loss rate (PLR) parameters from every groups. Offered traffic in PLR 10^{-2} for emergency group user is $G=0.7$ packet/slot without fading and $G=0.65$ packet/slot with fading, while for public group is $G=0.699$ packet/slot without fading and $G=0.42$ packet/slot with fading. Peak throughput for emergency group is $G=0.737$ packet/slot without fading and $G=0.729$ packet/slot with fading. Peak Throughput for public group is $G=0.699$ packet/slot without fading and $G=0.685$ packet/slot with fading. Throughput values of emergency group are higher than those of the general group, indicating successful process of giving priority for emergency group.

1. Introduction

There has been increasingly rapid development of information and communication technology indicated with rampant emerging new technologies. The year 2020 sees the 5th generation wireless telecommunication technology (5G) which present a new paradigm of applications involving "things" called Internet-of-things (IoT). Internet of Things consist of devices which have Internet Protocol addresses (IP), are connected to the internet network, and are able to exchange data or information with each other. IoT uses Machine-to-Machine (M2M) Communication which is supported by sensory devices which function like human senses. M2M communications is one of the important elements which will be able to support the future IoT technology. IoT uses broadband communication system when transferring large-sized data, and narrowband communication system when transferring small-sized data.

Having all objects connected to the internet, the number of the world's mobile subscriber was estimated to reach 6.6 billion at the end of 2018 and 9.3 billion at the end of 2019. This figure does not include that of machine to machine (M2M) and 50 billion devices which will be connected with each other. This figure has exceeded the number of the world population which is estimated to reach 8 billion by 2023 as shown in Figure 1 (United Nations, 2020).

Figure 2 shows the usage scenario of 5G technology (IMT-2020). It can be seen that 5G is used not only for broadband communication services, but also services requiring very low latency and massive machine type communications. Massive machine type communications which are the focus of this research mean devices to be connected to the internet network including sensors and radio frequency identification (RFID) the number of which are estimated to reach 10 billion devices, which is larger than the human population. This requires the IoT system to be able to serve more than 1 million devices within 1kilometer radius at the speed of 100 Mbps. This has motivated the development of efficient and effective techniques in wireless communication system, one of which is a research conducted by Anwar (2016b) which proposes the Coded random Access (CRA) technique on the Rayleigh fading channel for super-dense network.

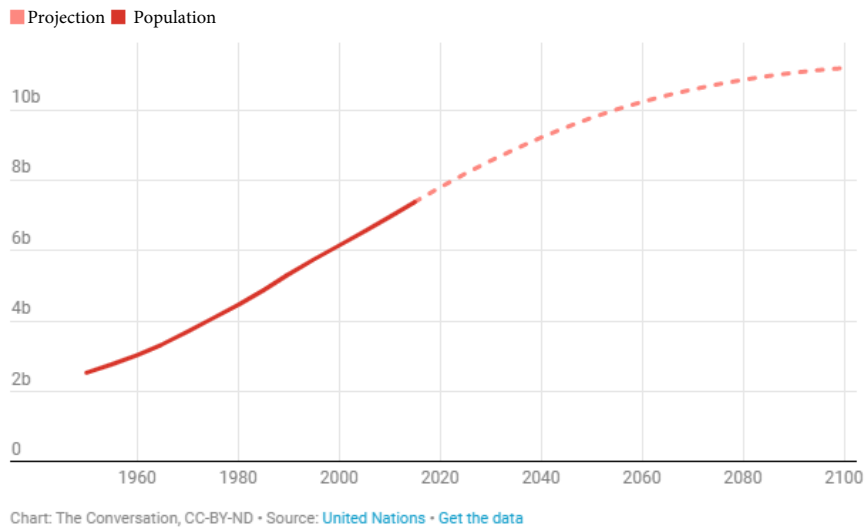

Figure 1. Human population exponential growth (Tjaja, 2009)

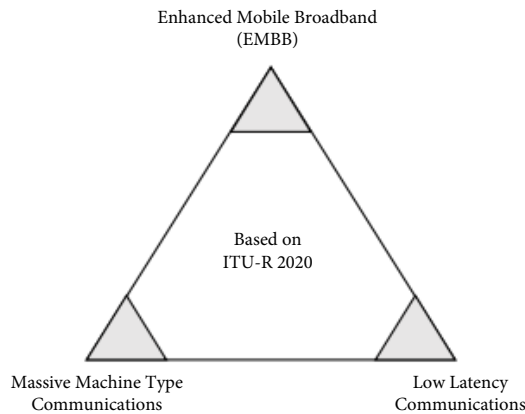

Figure 2. Usage scenario of 5G (Rancy, 2015)

The problem of massive-machine type communication has been resolved using the multiple access Coded Random Access (CRA) technique which can serve millions of users (Liva, 2011). A very large number of users or devices requires suitable and reliable multiple access technology. The multiple access CRA technique is very suitable for wireless super-dense networks on a 5G network for the estimated difficulty in scheduling thousands of devices. Random access is considered the easiest way that allows each user to choose any time-slot randomly. CRA can only work if the user can be detected perfectly.

This study uses multiple access CRA based on repetition codes and divides users into two groups, namely the emergency group and the general group. The emergency group uses a communication system during an emergency which includes, for instance, interactions between doctors in hospitals and officers in ambulances carrying patients. Meanwhile, the general group uses a communication system in non-emergency conditions, for example smartphone communication between parking sensors, lights and others. Objective of this study is to give priority to emergency communications in super-dense wireless networks. Given the mixing data of emergency and non-emergency communications in a super-dense wireless network, an optimal degree distribution is required for the emergency and general groups using EXIT chart projections followed up with evaluation of throughput and packet loss-rate (PLR) performance, both in the emergency group and in the general group.

2. Literature Review

2.1. Literature Review

A study conducted by Ni'amah et al. (2018) prioritizes the human group with 10:90 utility function user, which means that from a total of 100 users, the human group consists of 10 users and the machine group

consists of 90 users. The 1:0.8 utility function time-slot means that the human user group can access the entire time-slot while the machine group can only access 80% of the existing number of time-slot. Ni'amah et al (2018) do not use fading which results in human group rate of 0.073 and machine group of 0.33. For PLR 10-3 offered traffic, the result obtained is 0.7 packets/slot for the human group and 0.23 packets/slot for the machine group. Meanwhile, the throughput generated by the human group is 0.96 packets/slot and machine group 0.63 packets/slot. This study uses 100 users and 200 time-slots with a 50:50 utility function user which means there are 50 users in both emergency group and general group, while the utility function time-slot used is 1:0.8 which means that the entire existing 200 time-slots can be accessed by the emergency group user and only 160 time-slots can be accessed by the public group. In addition, this study also compares the effect of fading. This priority technique is employed by providing high throughput and small PLR in the emergency group.

Hasan and Anwar (2015) proposed a new technique using repetition codes to detect a very large number of users. The study finds the proposed degree distribution quite optimal, but it does not apply group division or give priority to emergency communication data. Another study conducted by Toni and Frossard (2015) validate theory and simulation for the division between priority and non-prioritized classes using the Irregular Repetition Slotted ALOHA (IRSA) code.

2.2. Coded Random Access (CRA)

Coded Random Access (CRA) is a multiple access technology which is important to this study, which is used for communication in super-dense networks. Coded in the term Coded Random Access in this study means the use of repetition codes as in Anwar and Astuti (2016). CRA is illustrated by bipartite graph in Figure 2. The circle represents the user node (UN), while the square represents the slot node (SN). CRA transmits data randomly, with the number of users is naturally fewer than the number of available time-slots to ensure the availability of one-degree time slots (Purwita & Anwar, 2016). The degree distribution for UN is expressed by $\Lambda(x)$ and SN with $\Omega(x)$ as shown in Figure 3.

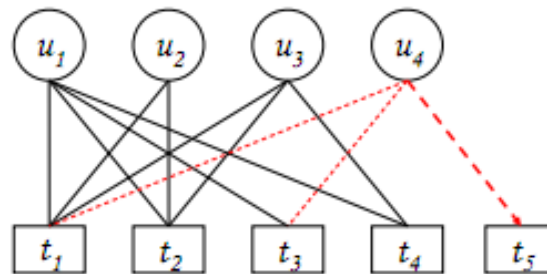

Figure 3. CRA illustrated with bipartite graph.

$$\Lambda(x) = \frac{1}{4}x^2 + \frac{2}{4}x^3 + \frac{1}{4}x^4 \dots\dots\dots 1)$$

and

$$\Omega(x) = \frac{1}{5}x + \frac{2}{5}x^2 + \frac{1}{5}x^3 + \frac{1}{5}x^4 \dots\dots\dots 2)$$

In large number (above 50) of users of UN and SN, the degree distribution $\Omega(x)$ is $\Omega(x) = \exp\left(-\frac{G}{R}x\right)$, with G is offered traffic and R is coding rate.

2.3. CRA based on Repetition codes

This research employs multiple access CRA based on repetition codes for communication in the priority of emergency group rather than the general group. The advantage of repetition codes is low level of complexity and easy to design and analyze because with repetition codes, a packet of information is duplicated to be sent to recipient. Repetition codes are very suitable for devices that only require a low data

rate such as light sensors, parking sensors, and the likes because these codes have smaller than 0.5 rate (Abbas et al., 2017).

The degree distribution used in this code is shown in equation (3) and the erasure probability from the UN in the emergency group is expressed as follows:

$$q^d = \sum_{\ell=2}^{n_c} \lambda_{\ell}^h (p^h)^{\ell-1} \dots\dots\dots 3)$$

Where,

λ_{ℓ}^d is the UN fraction on edge-perspective, and erasure probability for general group is q^u .

2.4. System Performance Parameter

To conduct system performance evaluation, the study measures the extrinsic information transfer (EXIT) chart, packet-loss rate (PLR), and throughput.

2.4.1. Extrinsic information transfer (EXIT) Chart

EXIT chart shown two or more representation of overall characteristics and system performance (Purwita & Anwar, 2016). EXIT chat on CRA is determined by UN degree distribution and SN degree distribution, thus it has two curves. Both curves are obtained from edge perspective degree distribution, namely the first derivative $\Lambda(x)$ of $\Omega(x)$ divided by $\Lambda'(1)$ or $\Omega'(1)$.

$$\lambda(x) = \frac{\Lambda'(x)}{\Lambda'(1)} \dots\dots\dots 4)$$

while edge perspective of SN degree distribution is

$$\omega(x) = \frac{\Omega'(x)}{\Omega'(1)} = \exp\left(-\frac{G}{R}x\right) \dots\dots\dots 5)$$

EXIT chart will present the mutual information, namely

$$I_{E,UN} = 1 - q \dots\dots\dots 6)$$

and

$$I_{E,SN} = 1 - p \dots\dots\dots 7)$$

with q is erasure probability from UN and p is erasure probability from SN. The relationship between p and q is expressed in equations 8 and 9.

$$q = \lambda(p) \dots\dots\dots 8)$$

$$1 - p = \omega(1 - q) \dots\dots\dots 9)$$

Figure 4 shows an EXIT chart, where the x-axis is UN apriori mutual information and SN extrinsic mutual information, and the y-axis is UN extrinsic mutual information and UN apriori mutual information. The UN curve always starts at point 0, while the SN curve does not start at point 0. The main target of the EXIT chart is to avoid an intersection point between the UN and SN curves before reaching the point (1,1). Performance evaluation is obtained based on the gap between the UN curve and the SN curve. The smaller the gap between the UN curve and the SN curve, the closer the performance to the Shannon limit (smaller error) (Arikan, 2009). The main objective of EXIT chart analysis in this study is to design the optimal degree distribution. This optimal degree distribution is used to produce the optimal performance of the repetition codes.

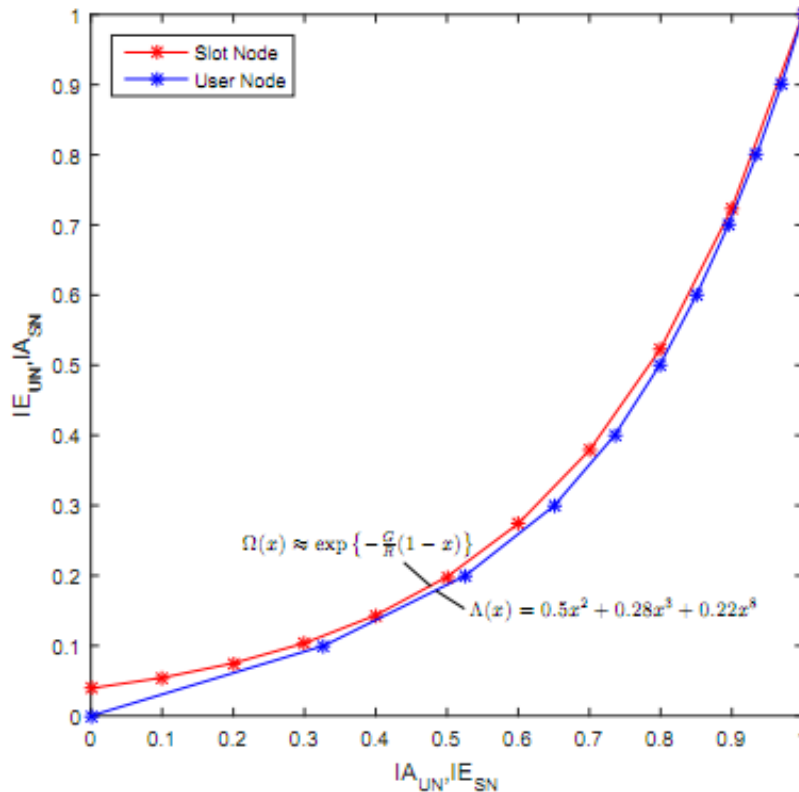

Figure 4. Illustration of EXIT chart

2.4.2. Packet-loss rate (PLR)

Packet-loss rate (PLR) is the ratio of the number of packets that are failed to be detected with the total packets sent. Packet loss occurs due to loss of packets on the way or packets received but not successfully detected (Kythe & Kythe, 2017).

$$P_L = \frac{b'}{b} \dots\dots\dots 10)$$

where:

- b' is the number of information received on the receiver after passing the channel
- b is original information

2.4.3. Throughput

Throughput is s the ratio of the number of packets received (without error) to the total number of packets sent including the wrong packets (Anwar et al., 2017). In other words, throughput is the success rate of well-received packet which is expressed by equation 11.

$$T = G \times (1 - P_L) \dots\dots\dots 11)$$

where:

- T = Throughput
- G = Offered traffic
- P_L = Packet-loss rate

3. Research Method

3.1. Transmitter

In the future, wireless telecommunication networks are predicted to have dense data exchange traffic, especially on the links between users and base stations (BS). The wireless network causes data to be prone to

loss when passing through the frequency-flat Rayleigh fading channel which results in an error-floor, which is a condition when the error does not decrease even though the noise is almost zero. The easiest solution to overcome network congestion is the CRA technique (Hasan & Anwar, 2015).

This research bases on single carrier transmission to keep the system simple because it does not require an equalizer. The modulation used is binary shift keying (BPSK). Repetition codes are designed for communication with very large amounts of data between users and base stations (BS). Repetition codes are very suitable for low data rates which have small transmission speeds, for example on sensors deployed on machines connected to the internet. An example of the structure transmitter for degree $d = 3$ is shown in Figure 5 where data is transmitted from transmitter with BPSK modulation to superimpose the carrier signal for transmission using three antennas.

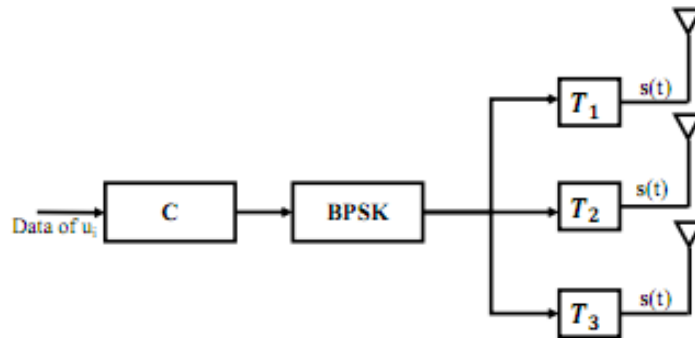

Figure 5. Transmitter for degree $d = 3$.

3.2. Channel Model

Messages or data will be sent using the channel. EXIT chart analysis uses a binary erasure channel (BEC) for easier analysis and the Rayleigh-fading frequency channel for identification of fading.

3.2.1. Binary Erasure Channel (BEC)

Because this research focuses on the network layer, the BEC channel is used in the EXIT chart. In a communication link, there is a possibility that the data received by the receiver contains wrong data (error) (Shokrollahi, 2006). Figure 6 shows BEC with an erasure probability P , which is the probability of data x being lost in the transmission process. BEC has a P value that usually ranges from $0 \leq p \leq 0,5$, with the input models of x_1 and x_2 and three outputs of y_1 , y_2 and y_3 . If a packet "0" is sent, the probability of being received is "e", similar principle also applies for bit "1" (Kythe & Kythe, 2017).

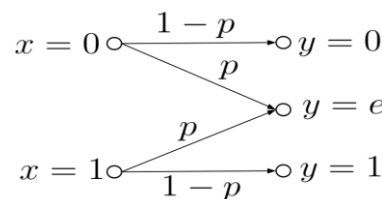

Figure 6. BEC with Erasure probability e

BEC with erasure probability e is shown in equation 12.

$$C - 1 - e \dots\dots\dots 12)$$

3.2.2. Frequency-flat Rayleigh Fading Channel

Rayleigh-fading frequency-flat channel is an information channel that contains only one path and the channel follows the Rayleigh distribution with a probability density function (pdf) (Anwar, 2016). Signals passing through the Rayleigh fading frequency-flat channel is received by the model as shown in equation 13.

$$y = h \cdot \bar{z} + n \dots\dots\dots 13)$$

The value of h in MATLAB programming follows equation 14.

$$h = \frac{randn + \sqrt{-1} * randn}{\sqrt{2}} \dots\dots\dots 14)$$

$randn$ is normally distributed pseudorandom generator with n is vector noise AWGN.

3.3. Receiver

On the receiver side, several processes are carried out to receive data without any errors. After passing through the transmission channel, signals are properly modulated using BPSK to detect packets to be sent to the time-slot. The symbols in the modulation will be coded using SIC based on bipartite graph (Ni'amah et al., 2018). CRA assumes proper synchronization and perfect detection headers to indicate the successive interference cancellation in the receiver's decoding scheme. Processes in SIC can easily be done by solving problems in the message received, such as minimizing problems with interference which results in reduced degree slot nodes. The receiver structure is shown in Figure 7.

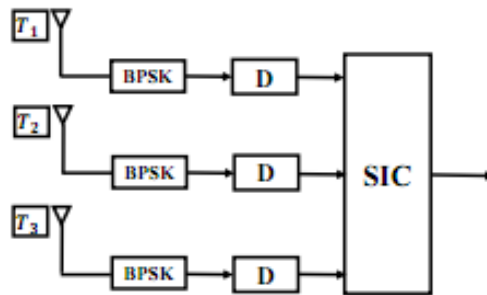

Figure 7. Receiver for degree $d = 3$.

3.4. Successive Interference Cancellation (SIC) Decoding on Repetition codes

SIC decoding for repetition codes is shown in Figure 6 with algorithm and procedures conducted as follow (Ni'amah et al., 2018):

- a. Process 1: Find user u_i that is connected to one of the time-slots with degree d . Delete the signal transmission on time-slot t_i which is connected to the u_i so that all signal transmissions are detected in the u_i user. In Figure 6 (a) user u has degree 1 and connected to t_5 so that all packets in user u_4 are received correctly without any error.
- b. Process 2: Conduct the first process repeatedly until there is no longer degree $d = 1$ are found. If no more degree of $d = 1$ is found, the decoding process stops as shown in Figure 6 (d), all users are detected successfully. If the decoding process stops when users which does not have degree 1 are still found, the process is called a "stopping set".

3.5. Emergency and General User Group grouping in future Network

This study employs a model system illustrated in Figure 9 where a number of users are divided into two groups of emergency and general in which both groups access time-slots freely and randomly. While the emergency group is free to access all time-slots, the general group is restricted in accessing time-slots in order to give priority to the emergency group. The circle symbol shows the user node (UN) with degree ℓ while the square symbol shows the node slot (SN) with degree d . Erasure probability from emergency group users is symbolized by q^d and erasure probability from the emergency group time-slot is p^d , and q^u and p^u for those of general group respectively.

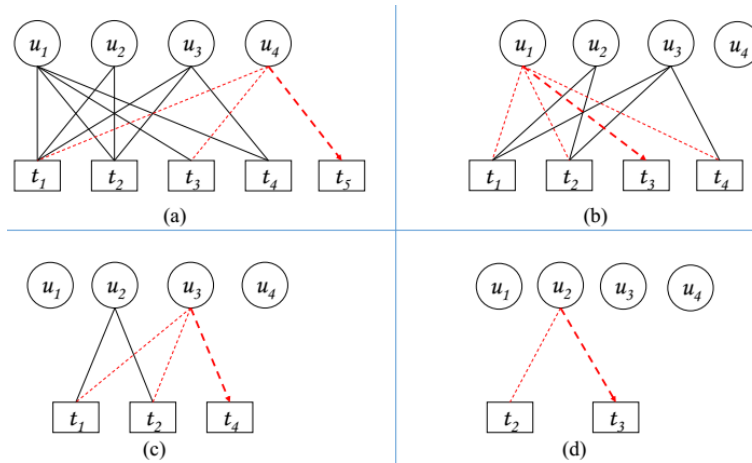

Figure 8. Procedure for decoding performance conducted on BS in super-dense network using repetition codes

The symbols $U_d = \{U_1^d, U_2^d, \dots, U_5^d\}$ indicates the emergency group, the symbols $U_u = \{U_6^u, U_7^u, \dots, U_{10}^u\}$ indicates the general group, and the total time-slots are denoted by $T = \{t_1, t_2, \dots, t_{20}\}$. To prioritize emergency groups, the emergency group is given freedom to access all time-slots while the general group can only access part of the time-slots. In accordance with the study model (Figure 7), the emergency group can access all 20 time-slots ($t_1 - t_{20}$) and the general group can only access 18 time-slots ($t_3 - t_{20}$). The target of such CRA scheme with priority is to maximize the number of M users. In this study, the number of M users is very large because it involves two groups, while Hasan and Anwar (2015) only involved one group. The total users in this study are the sum of the emergency and general groups = $M_d + M_u$. In CRA, the number of time slots N ($N_d < N_u$) is minimized to maximize the G (offered traffic) value. In this study, the human and machine group offered traffic (G) can be maximized because it is the sum of the human and machine group offered traffic, in contrast to the research of Hasan and Anwar (2015) which can only maximize offered traffic to one group. Offered traffic on emergency group priority follows Equation 15.

$$G = G_d + G_u \dots \dots \dots 15)$$

with

$$G_d = \frac{M_d}{N_d} \dots \dots \dots 16)$$

$$G_u = \frac{M_u}{N_u} \dots \dots \dots 17)$$

where:

- G_d and G_u are emergency and general group offered traffics.
- M_d and M_u are number of emergency and general group users.
- N_d and N_u are number of of emergency and general group time -slots.

3.6. Degree distribution on User Node (UN) and Slot Node (SN)

Degree distribution is the main characteristic of multiple access CRA techniques. Degree distribution is the distribution of the number of user transmissions and ensures the continuous process of transmission without any errors by using Successive Interference Cancellation (SIC) support on the receiver side. In SIC, there is continuous interference cancellation until a degree of one is achieved, which means that users who are in the time-slot are detected.

Although the slot node cannot be designed and controlled because of the unlimited number of time-slots, a large number of user nodes can be designed and controlled using a degree distribution (Anwar, 2016a). Degree distribution is the distribution of the number of user transmissions which is used to obtain high throughput and to ensure that the SIC can continue running until it reaches a degree of one so that all users can be detected. Degree distribution in the emergency group user node based on the node-perspective is expressed on the polynomial as follows

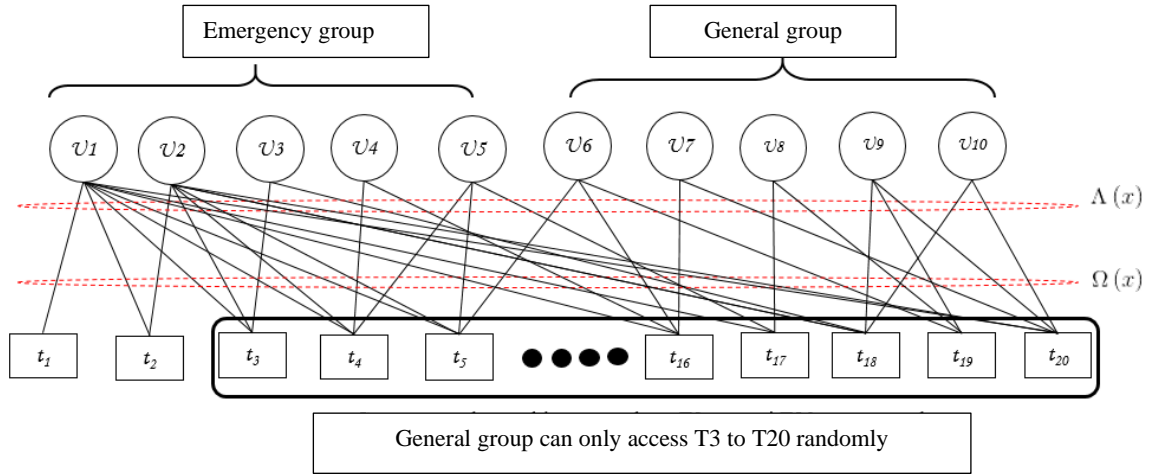

Figure 9. CRA Bipartite-graph on emergency and general user groups

$$\Lambda^d(x) = \sum_{\ell=2}^L \Lambda_{\ell}^d x^{\ell}, \dots \dots \dots 18)$$

where Λ_{ℓ}^d is fraction of UN on emergency group with degree ℓ .

To analyze network performance using EXIT chart, degree distribution based on edge-perspective is required, it is the first derivative of the node-perspective degree distribution divided by the first derivative of node-perspective by entering value=1. Degree distribution on emergency group UN based on edge-perspective is expressed with equation 19 (Ni'amah et al., 2018).

$$\lambda^d(x) = \frac{\Lambda'(x)}{\Lambda'(1)} = \sum_{\ell=0}^L \lambda_{\ell}^d x^{\ell-1}, \dots \dots \dots 19)$$

The degree distribution equation is applied also on general group with Λ^u for node perspective and $\lambda^u(x)$ for edge-perspective. With the degree equation, rate on emergency and general groups can be determined. Emergency group rate using repetition codes is expressed with equation 20 (Ni'amah et al., 2018).

$$R_d = \frac{1}{\sum_{h=2}^{nh} \Lambda^{dn^d}} \dots \dots \dots 20)$$

So as the general group rate which is expressed with R_u .

SN degree distribution with probability approximation on SN with degree d. SN Degree distribution is expressed with equation 21.

$$\psi_d = \binom{M_d}{d_d} \binom{M_u}{d_u} \left(\frac{G_d}{R_d M_d}\right)^{d_d} \left(\frac{G_u}{R_u M_u}\right)^{d_u} \left(1 - \frac{G_d}{R_d M_d}\right)^{M_d - d_d} \left(1 - \frac{G_u}{R_u M_u}\right)^{M_u - d_u} \dots \dots \dots 21)$$

where $d = d_d + d_u$. SN Degree distribution Polynomial is expressed with equation 22.

$$\Omega(x) = \sum_{d=0}^M \psi_d x^d = \left(1 - \frac{G_d}{R_d M_d} (1 - x_d)\right)^{M_d} \left(1 - \frac{G_u}{R_u M_u} (1 - x_u)\right)^{M_u} \approx \exp\left\{-\left(\frac{G_d}{R_d}\right) + \left(\frac{G_u}{R_u}\right) + \frac{G_d}{R_d} x_d + \frac{G_u}{R_u} x_u\right\} \dots \dots \dots 22)$$

where $x = x_d + x_u$. Since the number of SN is unlimited, SN degree distribution cannot be designed or controlled. Therefore, exponential polynomial is used.

4. Results and Discussions

4.1. Analysis of EXIT Chart Simulation Results

The study conducts evaluation of multiple access CRA techniques based on repetition codes with 100 users and N=200 time-slots with 50 trials to observe the changes on degree distribution in order to obtain optimum degree distribution. The optimum degree of distribution is a requirement for efficient and high quality results. Optimum degree distribution is obtained through optimization which is expressed in equation 23.

$$\begin{aligned}
 &\text{maximizing} && G = G_d + G_u, \\
 &\text{parameters} && N \leq 200 \\
 &&& T_d \geq T_u \\
 &&& \delta \leq 0,1 \\
 &&& f_{SN}(I_{A,SN}) > f_{UN}^{-1}(I_{E,UN}) \dots\dots\dots 23)
 \end{aligned}$$

where:

- N = time-slot
- δ = minimum target
- T_d and T_u are user throughput (emergency and general)
- f_{SN} and f_{UN} are curves from SN and UN EXIT functions

Optimization to give priority to human group is carried out by providing smaller rate and offered traffic to emergency group compared to general group. It is aimed at prioritizing the emergency group to obtain higher throughput values for emergency group than that of the general group. Based on degree distribution optimization, UN degree distribution sub-optimal values for emergency and general groups are obtained using equation 24.

$$\begin{aligned}
 \Lambda^d(x) &= 0,8x^3 + 0,2x^7, \\
 \Lambda^u(x) &= 0,7x^2 + 0,3x^4, \dots\dots\dots 24)
 \end{aligned}$$

Based on degree distribution in equation (24), 80 out of 100 users on the emergency group conducted three transmissions to the time-slot randomly. Meanwhile, 20 other users transmitted seven times to the time-slot randomly, resulted in R_d = 0,263 rate for emergency group users and R_u = 0,387 rate for the general group users. Seventy out of 100 users in general group transmitted twice to the time-slot randomly and 30 other users transmitted four times to the time-slot randomly. The rate for emergency and general group users is less than 0.5, complying with the repetition codes theory. Offered traffic on emergency group user is G_d = 0,375 packet/slot G_u = 0,468 packet/slot for general user group.

Designing optimum degree distribution requires EXIT chart analysis based on UN and SN edge-perspective degree distribution. On EXIT chart for emergency and general group users, CRA time-slots are affected by the emergency group user and general user group iterations. The EXIT curve between the UN-emergency group and the time-slots affected by the general group iteration is called the SN-general group vs SN-emergency group projection. On the other hand, the EXIT curve between the UN-general group and the time-slots affected by the emergency group iteration is called the projection-SN-emergency group vs UN-general group.

This research model channel using BEC channel so that it is assumed that colliding packets will be erased. The EXIT chart is expressed using mutual information for emergency group as seen in equation 25.

$$\begin{aligned}
 I_{E,UN}^d &= 1 - q^d \\
 I_{A,UN}^d &= 1 - p^d \dots\dots\dots 25)
 \end{aligned}$$

where:

$I_{E,UN}^d, I_{A,UN}^d$ is extrinsic mutual information and apriori mutual information for UN-emergency group, p^d and q^d are erasure probability into and from UN-emergency group. Similar mutual information is also employed in the general group $I_{E,UN}^u, I_{A,UN}^u$.

Direction of p^d and q^d is illustrated in Figure 7, so is the general group's p^u and q^u . The relationship between p^d and q^d is expressed for UN and SN.

$$q^u = \lambda^u(p^u) \dots\dots\dots 26)$$

and

$$1 - p^u = \omega^u(1 - q^u). \omega^u(1 - q^u) = \exp\left\{-\frac{G_d}{R_d}(1 - q^d) - \frac{G_u}{R_u}(1 - q^u)\right\} \dots\dots\dots 27)$$

the formula is also applied on the general group with erasure probability of q^u and p^u .

The EXIT curve is evaluated on a bipartite graph for emergency and general user groups with 200 time-slots and 50 iterations. Figure 10 shows EXIT chart projection on the UN emergency group to the SN general group. EXIT curve on user UN emergency group $\Lambda^d(x)$ is denoted in rounded symbol "o" and projections and the SN-of general group and UN emergency group is denoted in positive sign "+". The EXIT curve for UN emergency group and SN general group has a relatively small gap so that it has a small loss rate. The degree distribution is optimal enough to be used for emergency groups to ensure smooth communication in emergency conditions and allow prioritizing of emergency communications.

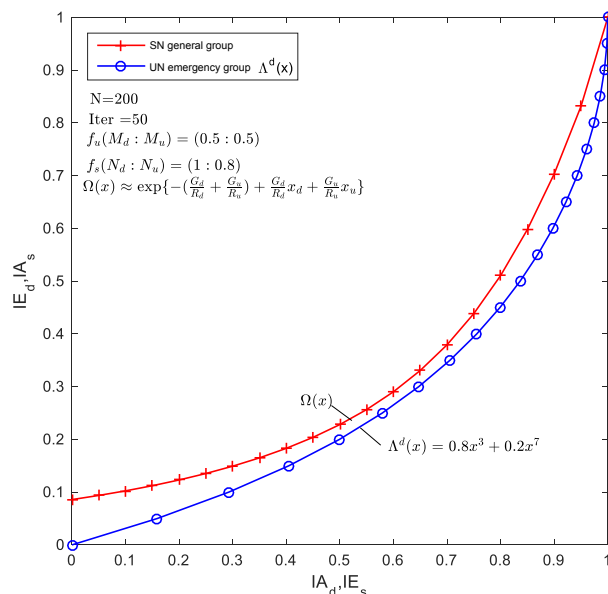

Figure 10. EXIT Chart projection on UN emergency group to SN general

Figure 11 shows the EXIT Chart projection on the UN general group to SN emergency group. EXIT curve on the general user UN group $\Lambda^u(x)$ is denoted in a rounded symbol "o" and the projection between the SN emergency group and UN general group is denoted in a positive "+" sign. The EXIT curve on UN general group and SN emergency group also has a small gap so that it has a small loss rate. Thus, the degree distribution is optimal enough for a fairly dense future network.

The degree distribution in this study belongs to the sub-optimal category which can be identified from in the EXIT chart projection graph which has a fairly wide gap between the UN and SN compared to the results of research by Ni'amah et al. (2018). This is because the time-slot utility functions provided for the

general group are fewer when compared to that of Ni'amah et al. (2018). In addition, the emergency and general groups share the same user utility function this study, whereas in Ni'amah et al. (2018) the number of human groups is less than the machine (0.1: 0.9). The optimal degree distribution, apart from being influenced by the utility function, is also influenced by fading, where Ni'amah et al. (2018) ignore the effects of fading.

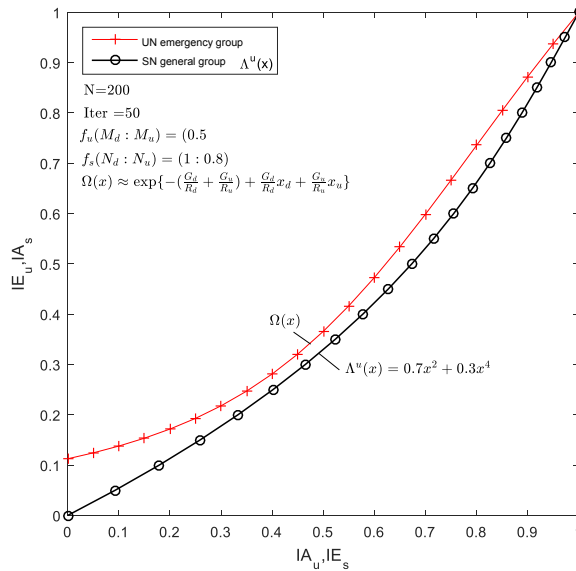

Figure 11. EXIT Chart projection on UN general group to SN emergency group

4.2. Analysis of Packet-loss rate (PLR) simulation results

Figure 12 shows the PLR curve for the degree of distribution $\Lambda^d(x)$, $\Lambda^u(x)$ with $N = 200$ and the comparison between the number of emergency user groups and general groups is 0.5: 0.5 and the comparison between time-slots used for emergency group user and general group user is : 0.8. Offered traffic obtained on PLR 10^{-2} for emergency group user without fading is $G = 0.7$ packet/slot and with fading is $G = 0.65$ packet/slot. Meanwhile, for the general group, offered traffic obtained without fading is $G = 0.6$ packet/slot and with fading is $G = 0.42$ packet/slot. It can be seen that the PLR for the emergency group is better than that of the general group, both with and without fading. The analysis results also showed that PLR without fading was better than PLR with fading.

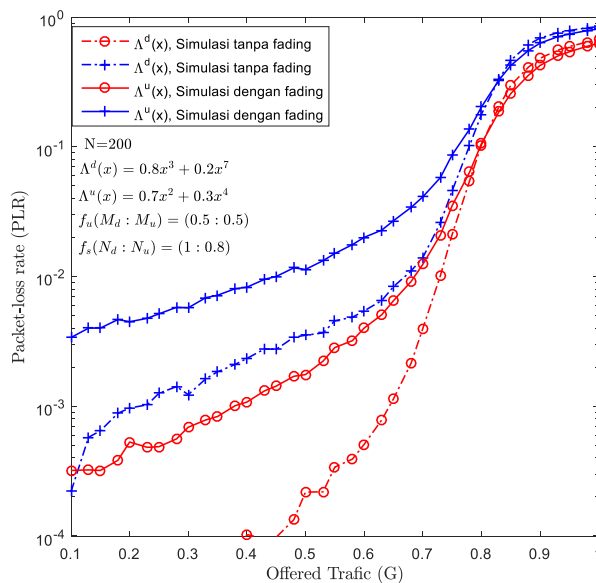

Figure 12. PLR performance graph

4.3. Throughput Simulation results analysis

Throughput can be calculated based on the PLR obtained from equation 11. Figure 13 shows the throughput resulted from the simulation with the number of time-slots (N) of 200. It can be seen that the peak throughput value for the emergency group without fading is $G = 0.737$ packet/slot and with fading is $G = 0.729$ packet/slot. Meanwhile, the peak throughput for the general group without fading is $G = 0.699$ packet/slot and with fading is $G = 0.685$ packet/slot. It can also be seen that the throughput value for the emergency group is higher than the general group. This shows the success of prioritizing communication in the emergency group compared to the general group.

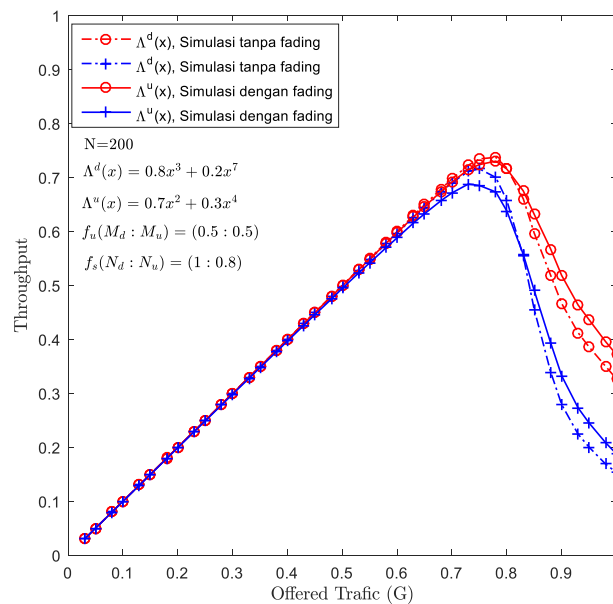

Figure 13. Throughput performance graph

The throughput generated in this study is smaller than this generated in Ni'amah et al. (2018) study because the degree distribution has not reached its optimal level in addition to the effect of fading. This fading effect greatly affects the performance of the CRA technique while Ni'amah et al. (2018) ignored this in their study.

5. Conclusions and Recommendations

The CRA technique using repetition codes in this research is very suitable to be applied on super-dense networks on SC-IoT to anticipate the increasing number of communications between devices on the future network. CRA performance is evaluated using the EXIT chart to obtain the most optimal degree distribution in the emergency group and general group, which is identified by the smallest gap on the user node (UN) curve and the slot node (SN) curve. Based on the simulation result curve, EXIT chart shows the degree distribution for the emergency group $\Lambda^d(x) = 0,8x^3 + 0,2x^7$ and for the general group $\Lambda^u(x) = 0,7x^2 + 0,3x^4$. This degree distribution performance evaluation can also be seen based on the PLR and the resulting throughput, whether with or without fading effect. Offered traffic on PLR 10^{-2} emergency user group obtained without fading is $G = 0.7$ packet/slot and with fading is $G = 0.65$ packet/slot. Meanwhile, for the general group, without fading is $G = 0.6$ packet/slot and with fading is $G = 0.42$ packet/slot. Throughput for emergency group without fading is $G = 0.737$ packet/slot and with fading is $G = 0.729$ packet/slot. Throughput peak value for general group without fading is $G = 0.699$ packet/slot and with fading is $G = 0.685$ packet/slot. The PLR value obtained in the emergency group was better than the general group despite the effect of fading, so that the throughput value in both groups was higher in the emergency group compared to the general group to ensure success in emergency communication. This study has several weaknesses including the user utility function and only one time-slot used. It is recommended that future studies include a more varied comparison of the number of users and time-slots. Another weakness is that the throughput and

PLR values generated in the emergency group have not been maximized. Another method is needed to increase to 0.9 packet/slot.

6. Acknowledgement

Appreciation for colleagues from the Purwokerto Telkom Institute of Technology and fellow lecturers, especially the cellular wireless research expertise group who have supported this study.

References

- Abbas, R., Shirvanimoghaddam, M., Li, Y., & Vucetic, B. (2017). Random Access for M2M Communications With QoS Guarantees. *IEEE Transactions on Communications*, 65(7), 2889–2903. <https://doi.org/10.1109/TCOMM.2017.2690900>
- Anwar, K. (2016a). *Coded Super-Dense Networks Exploiting Side Information for the Internet-of-Things* (IEICE Technical Report HPB2016). Tokyo Denki University.
- Anwar, K. (2016b). Decoding for wireless super-dense networks and its finite-length analysis for practical applications. *2016 International Symposium on Electronics and Smart Devices (ISESD)*, 347–354. <https://doi.org/10.1109/ISESD.2016.7886746>
- Anwar, K. (2016c). Graph-Based Decoding for High-Dense Vehicular Multiway Multirelay Networks. *2016 IEEE 83rd Vehicular Technology Conference (VTC Spring)*, 1–5. <https://doi.org/10.1109/VTCSpring.2016.7504263>
- Anwar, K., & Astuti, R. P. (2016). Finite-length analysis for wireless super-dense networks exploiting coded random access over Rayleigh fading channels. *2016 IEEE Asia Pacific Conference on Wireless and Mobile (APWiMob)*, 7–13. <https://doi.org/10.1109/APWiMob.2016.7811441>
- Anwar, K., Juansyah, Syihabuddin, B., & Adriansyah, N. M. (2017). Coded random access with simple header detection for finite length wireless IoT networks. *2017 Eighth International Workshop on Signal Design and Its Applications in Communications (IWSDA)*, 94–98. <https://doi.org/10.1109/IWSDA.2017.8097063>
- Arikan, E. (2009). Channel Polarization: A Method for Constructing Capacity-Achieving Codes for Symmetric Binary-Input Memoryless Channels. *IEEE Transactions on Information Theory*, 55(7), 3051–3073. <https://doi.org/10.1109/TIT.2009.2021379>
- Hasan, M. N., & Anwar, K. (2015). Massive uncoordinated multiway relay networks with simultaneous detections. *2015 IEEE International Conference on Communication Workshop (ICCW)*, 2175–2180. <https://doi.org/10.1109/ICCW.2015.7247504>
- Kythe, D. K., & Kythe, P. K. (2017). *Algebraic and Stochastic Coding Theory* (0 ed.). CRC Press. <https://doi.org/10.1201/b11707>
- Liva, G. (2011). Graph-Based Analysis and Optimization of Contention Resolution Diversity Slotted ALOHA. *IEEE Transactions on Communications*, 59(2), 477–487. <https://doi.org/10.1109/TCOMM.2010.120710.100054>
- Ni'amah, K., Ramatryana, I. N. A., & Anwar, K. (2018). Coded Random Access Prioritizing Human Over Machines for Future IoT Networks. *2018 2nd International Conference on Telematics and Future Generation Networks (TAFGEN)*, 19–24. <https://doi.org/10.1109/TAFGEN.2018.8580480>
- Purwita, A., & Anwar, K. (2016). Massive Multiway Relay Networks Applying Coded Random Access. *IEEE Transactions on Communications*, 1–1. <https://doi.org/10.1109/TCOMM.2016.2600562>
- Rancy, F. (2015). *IMT for 2020 and Beyond* (pp. 69–84). Radiocommunication Bureau, International Telecommunication Union. https://www.google.com/url?sa=t&rct=j&q=&esrc=s&source=web&cd=&cad=rja&uact=8&ved=2ahUKewjP9djt2KHtAhWCV30KHUjLDtQQFjAAegQIARAC&url=https%3A%2F%2Fwww.riverpublishers.com%2Fpdf%2Fbook%2Fchapter%2FRP_9788793379787C6.pdf&usq=AOvVaw3UVZnEp7ApoJnlQRBKfki
- Shokrollahi, A. (2006). Raptor codes. *IEEE Transactions on Information Theory*, 52(6), 2551–2567. <https://doi.org/10.1109/TIT.2006.874390>
- Tjaja, R. P. (2009). *Menuju Penduduk Tumbuh Seimbang Tahun 2020*. Bappenas. https://www.bappenas.go.id/index.php/download_file/view/10723/2439/
- Toni, L., & Frossard, P. (2015). Prioritized Random MAC Optimization Via Graph-Based Analysis. *IEEE Transactions on Communications*, 63(12), 5002–5013. <https://doi.org/10.1109/TCOMM.2015.2494044>