

PAPER NAME

Triple Band Notched Microstrip Antenna Using Planar Series 2x2 Element Array.pdf

AUTHOR

Alfin Triple Band Notched Microstrip Antenna Using Plana

WORD COUNT

2631 Words

CHARACTER COUNT

13115 Characters

PAGE COUNT

5 Pages

FILE SIZE

493.2KB

SUBMISSION DATE

Nov 15, 2022 7:47 PM GMT+7

REPORT DATE

Nov 15, 2022 7:47 PM GMT+7

● **20% Overall Similarity**

The combined total of all matches, including overlapping sources, for each database.

- 9% Internet database
- 11% Publications database
- Crossref database
- Crossref Posted Content database
- 15% Submitted Works database

● **Excluded from Similarity Report**

- Bibliographic material
- Quoted material
- Cited material
- Manually excluded sources
- Manually excluded text blocks

Triple Band Notched Microstrip Antenna Using Planar Series 2x2 Element Array for 5G Communication System

Syah Alam¹, Indra Surjati^{1,*}, Lydia Sari¹, Muhammad Reynaldhy Hilyawan¹,
Zahriladhda Zakaria², Noor Azwan Shairi², Alfin Hikmaturokhman³, Teguh Firmansyah⁴

¹ Department of Electrical Engineering, Universitas Trisakti, West Jakarta, Indonesia

² Faculty of Electronics and Computer Engineering, Universiti Teknikal Malaysia Melaka (UTeM),
Hang Tuah Jaya, 76100 Durian Tunggal, Melaka, Malaysia

³ Department of Telecommunication Engineering, Institut Teknologi Telkom Purwokerto, Central Java, Indonesia

⁴ Department of Electrical Engineering, Universitas Sultan Ageng Tirtayasa, Banten, Indonesia

(Received 12 January 2021; revised manuscript received 21 February 2022; published online 28 February 2022)

This research proposes the design of a wideband microstrip antenna with triple notch bands for the fifth generation (5G) communication system. The antenna is designed using FR-4 substrate with ϵ_r of 4.3, $\tan\delta$ of 0.0265 and a thickness of 1.6 mm. Triple notch bands are generated using a 2x2 element array configuration that connects each patch antenna in series and is arranged horizontally. From the simulation results, a triple band notched antenna is obtained with a resonant frequency of 3.15, 3.32 and 3.72 GHz. The fractional bandwidth (FBW) of the proposed antenna is 770 MHz or 22 % and the gain is 9.24 dB with an operating frequency of 3.5 GHz. The proposed antenna succeeded in increasing the bandwidth and gain up to 285 % and 55 %, respectively, compared to a single element antenna. The studied antenna design can be recommended as it is also very useful as a receiving antenna for the 5G communication system.

Keywords: Microstrip antenna, Planar series array, Bandwidth, Triple band notched antenna.

DOI: [10.21272/jnep.14\(1\).01019](https://doi.org/10.21272/jnep.14(1).01019)

PACS numbers: 84.40.Ba, 06.30.Ft

1. INTRODUCTION

The fifth generation (5G) communication system has been developed and has the advantages such as low latency and very high data transfer rates [1]. The data transfer speed and latency offered by the 5G communication system are up to 10 Gbps (gigabits per second) and 0.5 ms (milliseconds) and available at a frequency of 3.5 GHz [2]. To support the communication process between the customer and the provider, a transceiver device is needed that is useful for sending and receiving information signals. One of the recommended antennas for 5G communication systems is a microstrip antenna because it has the advantage of low profile, ease of manufacture and compact dimensions [3-5]. Several previous studies have described the application of microstrip antennas for 5G communication systems [6-8]. However, one of the disadvantages of microstrip antennas is narrow bandwidth, low gain and directivity. Several studies have been proposed to increase bandwidth, among others, by using coplanar waveguide (CPW) [9-11], proximity coupling [12], slot [13] and parasitic [14]. Furthermore, to increase the gain of microstrip antennas, several techniques have been described in previous studies, including array [15] and subarray [16]. The previous research proposed a microstrip antenna design with a 2x2 element array technique with the addition of stubs to optimize bandwidth [17], while another study [12] described an ultra-wideband antenna with a step line and a U-slot. However, the two studies only produced one notch of the operating frequency. This study proposes the design of a wideband microstrip antenna with a 2x2 element array configuration and arranged in a planar series for

the 5G communication system. The main contribution of this research is to produce an antenna that has a wide bandwidth, high gain and a triple notch band of resonant frequency, so that it can be used as a receiving antenna in the 5G communication system. From the simulation results, the bandwidth and gain of the proposed antenna increase up to 285 % and 55 %, respectively. The structure of this paper consists of the introduction, antenna design, simulation results and analysis, and the last section is the conclusion.

2. ANTENNA DESIGN

The structure and development stages of the proposed antenna are shown in Fig. 1.

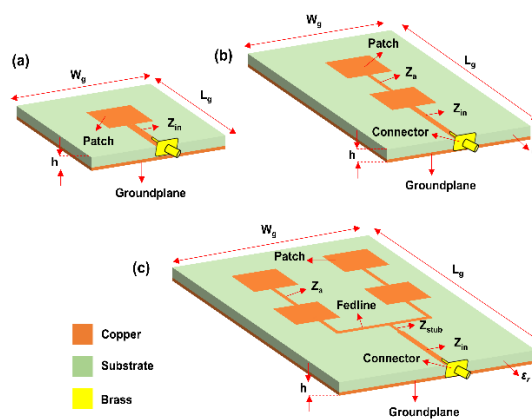

Fig. 1 – Design of the proposed antenna: (a) single element, (b) series array with 2x1 element, (c) planar series array with 2x2 element

* indra@trisakti.ac.id

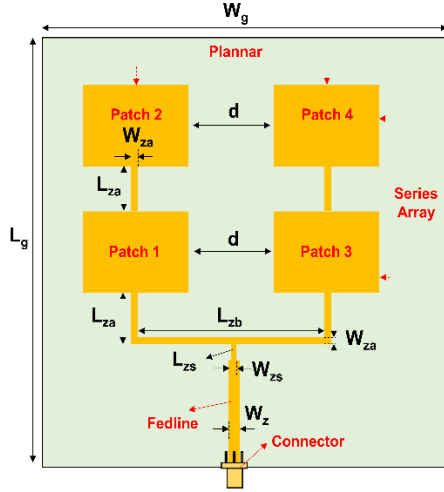

Fig. 2 – Dimension of a planar series array with 2x2 elements

The antenna is designed using FR-4 substrate with ϵ_r of 4.3, $\tan\delta$ of 0.0265 and thickness (h) of 1.6 mm. The initial stage starts with designing a single element antenna and then develops it using a series array with 2x1 elements. To produce triple notch and high gain, a planar array with 2x2 elements is proposed in this paper as a solution. The design of the microstrip antenna consists of a patch as a radiating element, a ground plane as a reflector, a feed line as an input, and matching impedance between the antenna and the connector. The impedance of the connector used is 50 Ohm, while the feed line used is a microstrip line. The structure of the proposed antenna is shown in Fig. 2. The dimensions of the microstrip antenna are obtained using the following equations [18]:

$$W = \frac{1}{2f\sqrt{\frac{\epsilon_r + 1}{2}}}, \quad (1)$$

$$L = L_{eff} - 2\Delta L, \quad (2)$$

$$\epsilon_{r_{eff}} = \frac{\epsilon_r + 1}{2} + \frac{\epsilon_r - 1}{2} \left[1 + 12 \frac{h}{W} \right]^{-2}, \quad (3)$$

$$\Delta L = 0.412h \frac{(\epsilon_{r_{eff}} + 0.3) \left(\frac{W}{h} + 0.264 \right)}{(\epsilon_{r_{eff}} - 0.258) \left(\frac{W}{h} + 0.8 \right)}, \quad (4)$$

$$W_z = \frac{2h}{\pi} \left\{ B - 1 - \ln(2B - 1) + \frac{\epsilon_r - 1}{2\epsilon_r} \left[\ln(B - 1) + 0.39 - \frac{0.61}{\epsilon_r} \right] \right\}, \quad (5)$$

where $B = \frac{60\pi^2}{Z_0\sqrt{\epsilon_{eff}}}$.

The geometry and dimensions of a series planar antenna with 2x2 elements are shown in Fig. 2, Table 1.

The radiating elements of the antenna array are separated by a distance denoted by d , this is aimed at increasing the antenna gain. Furthermore, the width of the feed line of the proposed antenna is adjusted to the

impedances used $Z_a = 100 \text{ Ohm}$, $Z_{in} = 50 \text{ Ohm}$ and $Z_{stub} = 70.7 \text{ Ohm}$. The overall dimensions of the proposed antenna are shown in Table 1.

The application of a stub is aimed at reducing the reflection coefficient of the antenna. Moreover, the distance between elements denoted d and stub impedance are determined using the following equations:

$$d = \frac{1}{4}, \quad (6)$$

$$Z_{stub} = \sqrt{Z_{in} \cdot Z_a}. \quad (7)$$

Table 1 – Dimensions of the proposed antenna

Parameter	Dimension (mm)
W_g	90
L_g	120
W	26
L	20
W_z	3
L_z	41
W_{za}	2.1
L_{za}	12
W_{zs}	1
L_{zs}	5

The dimensions of the feed line with impedances of 50, 70.7 and 100 Ohms are denoted by the parameters W_z , W_{zs} and W_{za} , respectively. Furthermore, the dimensions of the substrate are denoted by the parameters W and L , while W_g and L_g denote the dimensions of the radiating element, and the distance between the elements is denoted by d .

3. RESULTS AND DISCUSSION

3.1 Simulation Results

The simulation process is carried out using EM simulation software by observing the reflection coefficient, VSWR, impedance and gain of the three proposed antennas. The simulation results of a single element antenna are shown in Fig. 3.

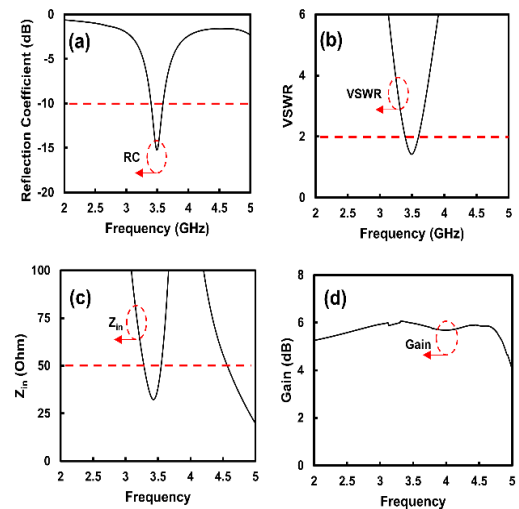

Fig. 3 – Simulation results of the single element antenna: (a) reflection coefficient, (b) VSWR, (c) Z_{in} , (d) gain

Fig. 3 shows that the single element antenna operates at a resonant frequency of 3.5 GHz with a reflection coefficient of -15.21 dB, VSWR of 1.42, impedance of 38.61 Ohms and gain of 5.97 dB. The bandwidth of the single element antenna is 200 MHz with a frequency range of 3.4 - 3.6 GHz. Furthermore, the simulation results of a series array antenna with 2×1 elements are shown in Fig. 4.

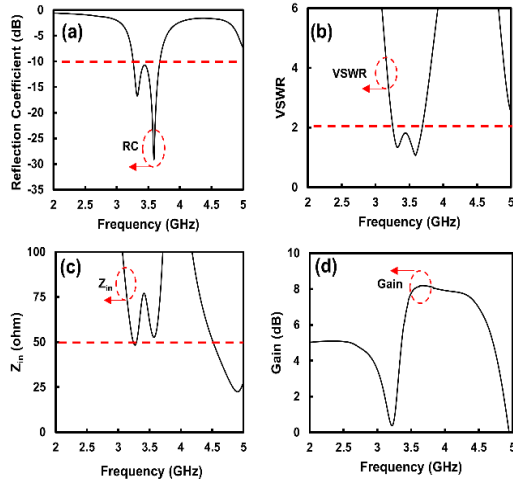

Fig. 4 – Simulation results of the series array antenna with 2×1 elements: (a) reflection coefficient, (b) VSWR, (c) Z_{in} , (d) gain

Fig. 4 shows that the series array antenna with 2×1 elements produces a wider bandwidth than the single element antenna, which is 420 MHz from the frequency range of 3.26 - 3.68 GHz. Furthermore, the series array antenna also produces two notch bands which have the best reflection coefficients of -29.05 dB at a resonant frequency of 3.59 GHz and -16.69 dB at a frequency of 3.32 GHz. The gain of the proposed antenna is also increased to 7.76 dB at a resonant frequency of 3.5 GHz while the impedance of the two notch bands is close to 50 Ohms. Furthermore, the simulation results of the reflection coefficient, VSWR, impedance and gain of a series planar array antenna with 2×2 elements are shown in Fig. 5.

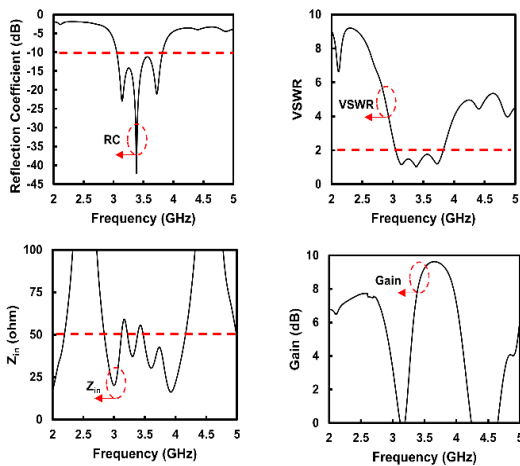

Fig. 5 – Simulation results of the series planar array antenna with 2×2 elements: (a) reflection coefficient, (b) VSWR, (c) Z_{in} , (d) gain

Fig. 5 shows that the series planar array antenna with 2×2 elements produces a wide bandwidth of 770 MHz with a resonant frequency range of 3.05 - 3.82 GHz. Furthermore, the proposed antenna produces three different notch bands at the resonant frequencies of 3.14 , 3.38 and 3.72 GHz with the reflection coefficients of -22.69 , -42.08 and -21.46 dB, respectively. The gain of the planar array antenna is increased up to 9.24 dB and the impedance of the three notch bands is in the range of 50 Ohms.

3.2 Analysis of Simulation Results

Simulation results of the three antenna models were analyzed to observe the impact and changes in antenna characteristics before and after optimization with a series array and a series planar array. The parameters to be compared are the resonant frequency, bandwidth and gain of the proposed antenna. A comparison of the reflection coefficients of the three proposed antenna models is shown in Fig. 6.

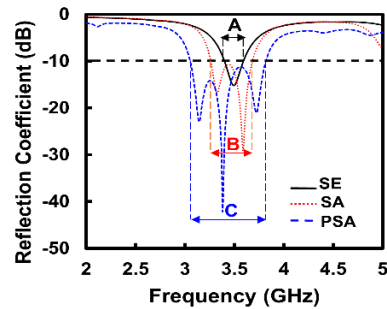

Fig. 6 – Comparison of reflection coefficient simulation results for three models of the proposed antenna

Fig. 6 shows that the antenna bandwidth is significantly increased with the addition of a series array and a series planar array. The antenna design with a series array has succeeded in increasing the bandwidth performance up to 110% , while with a series planar array – up to 285% compared to single element antennas, as indicated by A, B and C. Moreover, the number of notch bands of the proposed antenna also increases. The number of notch bands on a series array antenna is two at 3.2 and 3.59 GHz, while a series planar array gives three notch bands at 3.14 , 3.38 and 3.72 GHz. Fig. 7 shows a comparison of the gains for the three proposed antennas.

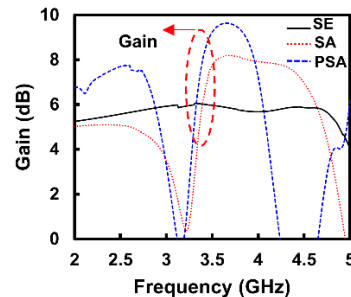

Fig. 7 – Comparison of gain simulation results

Fig. 7 shows that the gain of the proposed antenna is also significantly increased. The antenna gain in-

creased up to 30 % and 54.7 % after optimization with a series array and a series planar array, respectively. The radiation patterns of the three proposed antenna models are shown in Fig. 8.

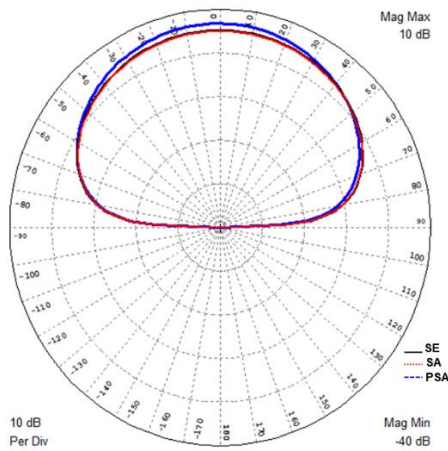

Fig. 8 – Comparison of radiation pattern simulation results

REFERENCES

1. M. Höyhtyä, O. Apilo, and M. Lasanen, *Futur. Internet* **10**, 3 (2018).
2. S. Hobbs, *Valuing 5G Spectrum: Valuing the 3.5 GHz and C-Band Frequency Range*, 1 (2018).
3. S. Alam, I. Surjati, A. Ferawan, T. Firmansyah, *Indones. J. Electr. Eng. Informatics* **6**, No 1, 70 (2018).
4. H. Wang and G. Yang, *2017 Int. Workshop Antenna Technol.: Small Antennas Innovat. Struct. Appl. (iWAT)*, 331 (2017).
5. S. Alam, I. Surjati, T. Firmansyah, *Int. J. Electr. Electron. Eng. Telecommun.* **10** No 1, 60 (2021).
6. H. Ali, P. Singh, S. Kumar, T. Goel, *2017 IEEE Int. Conf. Antenna Innovat. Modern Technol. Ground, Aircraft Satellite Appl. (iAIM)*, 1 (2017).
7. J. Maharjan, D. Y. Choi, *Int. J. Antennas Propag.* **2020**, 8760297 (2020).
8. A. Biswas, V.R. Gupta, *Wirel. Pers. Commun.* **111**, 1695 (2020).
9. D. Mitra, B. Ghosh, A. Sarkhel, S.R.B. Chaudhuri, *IEEE Trans. Antennas Propag.* **64**, 300 (2016).
10. Y.I. Abdulkarim, L. Deng, Halgurd N. Aw, Fahmi F. Muhammadsharif, O. Altintas, M. Karaaslan, H. Luo, *Materials (Basel)* **13**, 142 (2020).
11. P.V. Naidu, A. Malhotra, *Prog. Electromagn. Res. C* **57**, 159 (2015).
12. E. Sandi, Rusmono, A. Diamah, K. Vinda, *J. Commun.* **15** No 2, 198 (2020).
13. S. Yu, H. Zhang, D. Yu, *2017 IEEE 6th Asia-Pacific Conf. Antennas Propag. (APCAP)*, 1 (2018).
14. K. Da Xu, J. Zhu, S. Liao, Q. Xue, *IEEE Access* **6**, 42497 (2018).
15. S. Kundu, *Microw. Opt. Technol. Lett.* **63**, 869 (2021).
16. A.R. Pratiwi, E. Setijadi, G. Hendratoro, *Proceed. 2020 Int. Seminar Intelligent Technol. Appl. Humanification Reliable Intelligent Systems (ISITIA)* **2020**, 311 (2020).
17. S. Alam, I. Surjati, L. Sari, A. Anindito, A.Y. Putranto, T. Firmansyah, *Prz. Elektrotechniczny* **97**, 40 (2021).
18. D.-G. Fang, *Antenna theory and microstrip antennas* (CRC Press: 2017).

Мікросмужкова антена з трьома режекторними смугами з використанням планарного масиву послідовних елементів 2x2 для системи зв'язку 5G

Syah Alam¹, Indra Surjati¹, Lydia Sari¹, Muhammad Reynaldhy Hilyawan¹,
Zahriladhda Zakaria², Noor Azwan Shairi², Alfin Hikmaturokhman³, Teguh Firmansyah⁴

¹ Department of Electrical Engineering, Universitas Trisakti, West Jakarta, Indonesia

² Faculty of Electronics and Computer Engineering, Universiti Teknikal Malaysia Melaka (UTeM), Hang Tuah Jaya, 76100 Durian Tunggal, Melaka, Malaysia

³ Department of Telecommunication Engineering, Institut Teknologi Telkom Purwokerto, Central Java, Indonesia

⁴ Department of Electrical Engineering, Universitas Sultan Ageng Tirtayasa, Banten, Indonesia

У дослідженні пропонується конструкція широкосмугової мікросмужкової антени з трьома режекторними смугами для системи зв'язку п'ятого покоління (5G). Антена розроблена з використанням підкладки FR-4 з $\epsilon_r = 4,3$, $\tan\delta = 0,0265$ і товщиною 1,6 мм. Потрібні режекторні смуги генеруються за допомогою конфігурації масиву з 2x2 елементів, в якій патч-антени з'єднані послідовно і розташовані горизонтально. За результатами моделювання отримано антену з трьома режекторними смугами з резонансною частотою 3,15, 3,32 та 3,72 ГГц відповідно. Відносна ширина смуги пропускання (FBW) пропонуваної антени становить 770 МГц або 22 %, а коефіцієнт підсилення складає 9,24 дБ при робо-

чій частоті 3,5 ГГц. Запропонована антена дозволила збільшити смугу пропускання та отримати коефіцієнт підсилення до 285 % та 55 % відповідно, у порівнянні з одноелементною антеною. Вивчена конструкція антени може бути рекомендована, оскільки вона є дуже корисною як приймальна антена для системи зв'язку 5G.

Ключові слова: Мікросмужкова антена, Планарний послідовний масив, Смуга пропускання, Антена з трьома режекторними смугами.

● **20% Overall Similarity**

Top sources found in the following databases:

- 9% Internet database
- Crossref database
- 15% Submitted Works database
- 11% Publications database
- Crossref Posted Content database

TOP SOURCES

The sources with the highest number of matches within the submission. Overlapping sources will not be displayed.

1	ijeetc.com Internet	4%
2	Institute of International Studies on 2022-10-08 Submitted works	1%
3	Universitas Mercu Buana on 2022-11-06 Submitted works	1%
4	Braun, H., O.H. Karabey, M. Letz, A. Mehmood, R. Jakoby, and M. Ayluc... Crossref	<1%
5	Kuala Lumpur Infrastructure University College on 2015-01-27 Submitted works	<1%
6	karyailmiah.trisakti.ac.id Internet	<1%
7	Abhishek Sarkhel, Sekhar Ranjan Bhadra Chaudhuri. "Enhanced-gain pr... Crossref	<1%
8	ijmcr.com Internet	<1%

9	Universiti Teknologi MARA on 2018-04-22	<1%
	Submitted works	
10	erewhon.superkuh.com	<1%
	Internet	
11	Universiti Malaysia Pahang on 2017-02-18	<1%
	Submitted works	
12	"Recent Trends in Electronics and Communication", Springer Science a...	<1%
	Crossref	
13	P.C. Praveen Kumar, P. Trinatha Rao. "Frequency-tunable circularly pol...	<1%
	Crossref	
14	Panjab University on 2014-07-24	<1%
	Submitted works	
15	cyberleninka.org	<1%
	Internet	
16	Multimedia University on 2018-03-07	<1%
	Submitted works	
17	University of Mosul on 2016-08-15	<1%
	Submitted works	
18	Vietnam Maritime University on 2015-11-07	<1%
	Submitted works	
19	Heriot-Watt University on 2021-04-13	<1%
	Submitted works	
20	Lo, W.K., C.H. Chan, and K.M. Luk. "Circularly polarised microstrip ante...	<1%
	Crossref	

21	Panjab University on 2014-09-07	<1%
	Submitted works	
22	University of Surrey on 2019-11-06	<1%
	Submitted works	
23	Unviersidad de Granada on 2022-09-09	<1%
	Submitted works	
24	hdl.handle.net	<1%
	Internet	
25	International Islamic University Malaysia on 2019-04-12	<1%
	Submitted works	
26	International Islamic University Malaysia on 2018-05-11	<1%
	Submitted works	
27	K. Kaboutari, A. Zabihi, B. Virdee, Mostafa Pilevari Salmasi. "Microstrip..."	<1%
	Crossref	
28	Universiti Teknologi MARA on 2016-07-10	<1%
	Submitted works	
29	Puria Bairami, Mahdi Zavvari. "Broad band circularly polarized square s..."	<1%
	Crossref	
30	jpier.org	<1%
	Internet	

● Excluded from Similarity Report

- Bibliographic material
- Cited material
- Manually excluded text blocks
- Quoted material
- Manually excluded sources

EXCLUDED SOURCES

jnep.sumdu.edu.ua

75%

Internet

essuir.sumdu.edu.ua

75%

Internet

EXCLUDED TEXT BLOCKS

Triple Band Notched Microstrip Antenna Using Planar Series 2?2 Element Arrayfor ...

sinta.lldikti6.id

JOURNAL OF NANO- AND ELECTRONIC PHYSICSVol. 14 No

Universitas Mercu Buana on 2022-11-06

1 Department of Electrical Engineering, Universitas Trisakti, West Jakarta, Indonesia

Universitas Mercu Buana on 2022-11-06

2 Faculty of Electronics and Computer Engineering, Universiti Teknikal Malaysia M...

eprints.utm.edu.my

Telecommunication Engineering, Institut Teknologi Telkom Purwokerto, Central Ja...

inass.org

Department

www.ijeetc.com

revised manuscript received

Universitas Mercu Buana on 2022-11-06

21 February

epjplus.epj.org

DOI: 10.21272/jnep.14

Universitas Mercu Buana on 2022-11-06

as a receiving antenna

Universitas Mercu Buana on 2022-11-06

indra@trisakti.ac.id2077-6772/2022/14

Universitas Mercu Buana on 2022-11-06

1J. NANO- ELECTRON. PHYS. 14

Universitas Mercu Buana on 2022-11-06

2022 Sumy State University

Universitas Mercu Buana on 2022-11-06

3. RESULTS AND DISCUSSION3.1 Simulation ResultsThe simulation

mdpi-res.com

ACKNOWLEDGEMENTSThe authors express their gratitude to the ResearchInstitut...

Universitas Mercu Buana on 2022-11-06

ANTENNA DESIGNThe structure and

University of Mosul on 2016-08-15

in this paper.The bandwidth and

Teguh Firmansyah, Supriyanto Praptodiyono, Herudin Herudin, Didik Aribowo, Syah Alam, Dian Widi Astuti, ...
